

Alpha[®] Mini Air Polisher Instruction Manual

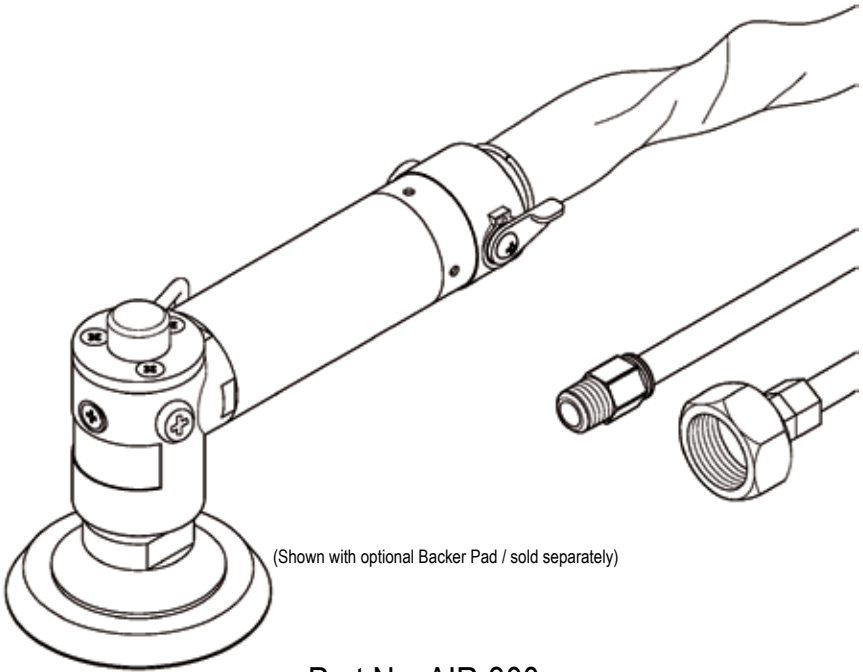

(Shown with optional Backer Pad / sold separately)

Part No: AIR-300
Version 2

For repair information call:

Headquarters, Oakland, NJ — (800) 648-7229

Due to specially designed components this machine must be serviced only with genuine ALPHA[®] parts.

 **Alpha Professional Tools**[®]

►TABLE OF CONTENTS

Introduction.....3

About the Symbols3

Safety Instructions for Power Tools3

Air-300 Overview6

Special Feature6

Specifications6

Accessories6

Tool Set-up Information6

 Attaching the Water, Air and Exhaust Hose to the Body.....6

Air Fittings And Pressure7

Spindle Size8

Air Valve Lever8

Water Supply Hose9

Silencer / Muffler9

Maximum Size for Polishing Pads.....9

Alpha® Air-300 Mini Air Polisher Schematic.....10

Alpha® Air-300 Mini Air Polisher Parts List.....11

Appendix A

 Greasing the Tool Housing12

Accessories and Factory Service14

Product Registration Card15

► INTRODUCTION

Thank you for purchasing an Alpha® Air Polisher. This polisher is ideal for intricate polishing such as bowl or sink-rim applications. A wide range of accessories help you perform many different tasks. This tool lets you polish all kinds of granite, marble, engineered stone and concrete. You can easily change from one type of disc to another in just a matter of seconds. The tool is used with water to help you get the best possible finish, to reduce the health risks of dust, and to give the most savings in time and money from modern accessories. For your safety, please read this manual thoroughly before you start operating this polisher.

► ABOUT THE SYMBOLS

According to the hazard level, all safety notes in this manual are classified into “DANGER”, “WARNING”, and “CAUTION”.



DANGER!

Death or serious personal injury is imminent when handling this polisher incorrectly.



WARNING!

There is a possibility of death or serious personal injury when handling this polisher incorrectly.



CAUTION!

There is a possibility of personal injury or property damage when handling this polisher incorrectly.

Note: In some situations, failing to observe WARNING notes could result in death or serious personal injury. Be sure to read and observe the safety notes to ensure safety and correct use of the polisher.

► SAFETY INSTRUCTIONS FOR POWER TOOLS

1. **KNOW YOUR POWER TOOL.** Read owner’s manual carefully. Learn its applications and limitations as well as specific potential hazards particular to this tool.
2. **KEEP WORK AREA CLEAN.** Cluttered areas and benches invite accidents.
3. **AVOID DANGEROUS ENVIRONMENTS.** Keep work areas as dry as possible. Do not use tool in presence of flammable liquids or gases. Keep the area well lit.
4. **KEEP CHILDREN AND VISITORS AWAY.** All visitors should be kept a safe distance from the work area. Keep out of reach of children.

5. **DON'T FORCE TOOL.** It will do the job better and safer at the rate for which it was designed.
6. **WEAR PROPER APPAREL.** Do not wear loose clothing or jewelry as it can get caught in moving parts. Rubber gloves and insulated non-skid footwear are recommended. Wear protective covering to contain long hair.
7. **WEAR PROPER EYE PROTECTION.** Use safety glasses at all times. Also, use a face mask if work area is dusty.
8. **WEAR PROPER EAR PROTECTION.** Wear ear protectors when using for extended periods.
9. **DON'T ABUSE WATER SUPPLY HOSE.** Don't carry tool by supply hose or expose to traffic areas where it can be crushed.
10. **ALWAYS SECURE WORK PIECE.** Use clamps or a vise to hold work. It's safer than using your hand and it frees both hands to operate tool.
11. **DON'T OVERREACH.** Keep proper footing and balance at all times.
12. **DISCONNECT TOOLS WHEN NOT IN USE.** Always disconnect tool before servicing; when changing accessories such as grinding wheels, backer pads, etc.
13. **REMOVE ADJUSTING KEYS AND WRENCHES.** Form a habit of checking to see that keys and adjusting wrenches are removed from tool before turning it on.
14. **MAINTAIN TOOLS WITH CARE.** Keep tools clean at all times for best and safest performance. Follow instructions for lubricating and changing accessories. Keep handles dry, clean and free of oil or grease. Inspect moving parts for alignment and binding as well as for breakage and improper mounting.
15. **AVOID ACCIDENTAL STARTING.** Don't carry a "connected" tool, or make adjustments, or change discs without making sure the air valve is in the off position to prevent the flow of air.
16. **USE ONLY RECOMMENDED ACCESSORIES.** The use of any accessories other than what is listed or recommended for this particular tool may be hazardous.
17. **KEEP HANDS AWAY FROM ALL MOVING PARTS.**
18. **USE SIDE HANDLES.** Supplied with tool for control and safety.
19. **STAY ALERT.** Watch what you are doing and use common sense. Do not operate tool when you are tired, or under the influence of medication or alcohol.

► AIR-300 OVERVIEW

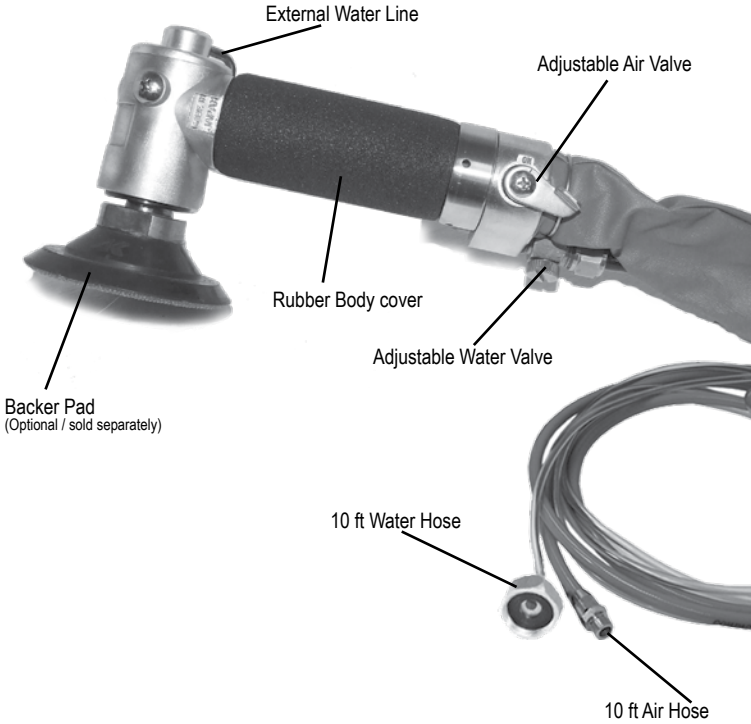

Figure-1

► SPECIAL FEATURE

The Alpha® Air Polisher was designed with human engineering for operator comfort. It comes equipped with a silencer which reduces the level of noise as well as guiding the cold exhaust air away from an operator during the polishing process. This feature also eliminates excess lubricant dripping on the work piece. Portions of the body design are made with synthetic materials and covered with rubber to prevent fatigue and coldness to hands.

► SPECIFICATIONS

	RPM	Weight	Air Consumption	Air Pressure	Air Inlet	Water Inlet	Spindle
U.S.	No Load 5,800	1.60 lb	10 CFM	87 PSI	BSPT 1/4"	BSP 1/4"	5/8"-11
METRIC		.731 kg	280 l/ Min	0.6Mpa (6 bar)			

► ACCESSORIES

Water hose (10 ft / 3m).....	1pc
Air hose (10 ft / 3m).....	1pc
Wrench (17mm)	1pc
Lubrication Oil (1oz / 30 cc sample bottle).....	1pc
Faucet/Garden Hose Adapter	1pc

► TOOL SET-UP INFORMATION

Unpack the tool carefully and study the helpful hints and warnings contained in this manual. Please take time to familiarize yourself with the features of the tool. See page 15 for more information about product registration or visit us on the web at www.alpha-tools.com.

Attaching the Water, Air and Exhaust Hoses to the body

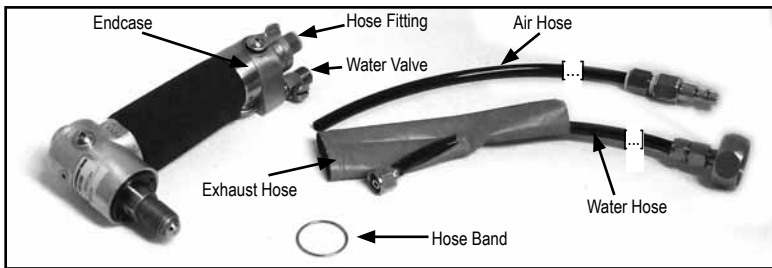

Figure-2

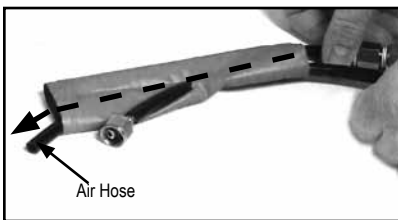

Figure-3

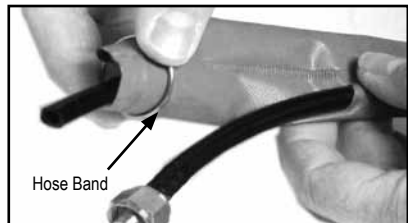

Figure-4

1. Push Air Hose through open end in the exhaust hose as shown in the Figure 3.
2. Slide hose band over exhaust hose as shown in Figure 4.

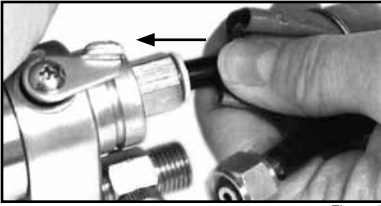

Figure-5

3. Push air hose into hose fitting.

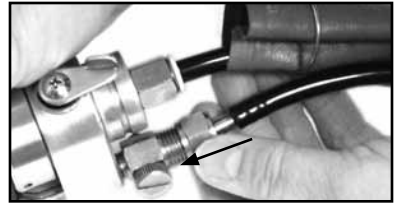

Figure-6

4. Insert water hose into water valve and tighten.

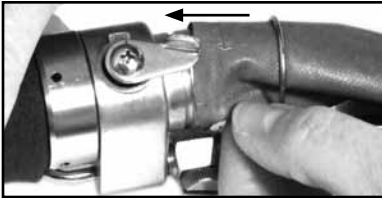

Figure-7

5. Place exhaust hose over valve case.

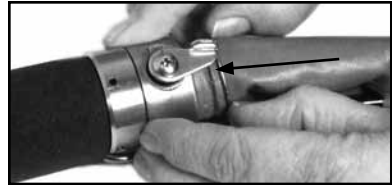

Figure-8

6. Slide hose band onto groove in valve casing for a snug fit.

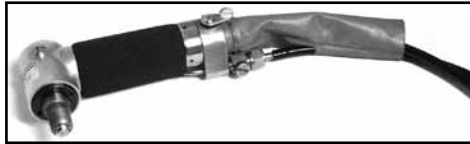

Figure-9

► AIR FITTINGS AND PRESSURE

Your new Alpha® polisher is designed for continuous duty polishing. When selecting your compressor, buy a system which can handle a constant flow of air. We recommend that you purchase a heavy duty two stage cast iron type unit. The system should include a regulator and a moisture trap.

- Each tool requires: 87 PSI (0.6Mpa / 6 bars); however the range of 85-90 PSI is acceptable. (6 kg / cm²) of air pressure and 10 CFM (280 ℓ / min.) of air flow.
- Although a 3HP air compressor delivers sufficient air pressure / volume, we suggest a minimum of 5 HP air compressor with a holding tank of 50 cubic feet (1,400 l) capacity for one tool.
- Air hose fitting is BSPT 1/4"
- The use of heavy duty 3/8" (10mm) hose is suggested for all lines.

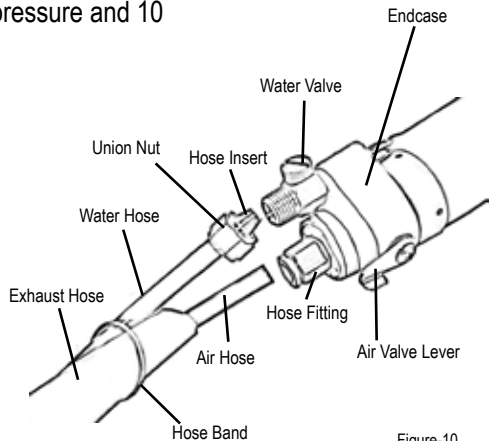

Figure-10

► **LUBRICATION** (Lube Oil is used to protect the tool from rusting when not in use)
PROPER CARE AND LUBRICATION ARE IMPORTANT FACTORS IN THE USEFUL LIFE OF THIS TOOL.

At the end of each workday, 2-3 drops of lubricant oil, solvent free oil (included with each polisher) should be placed in the air inlet at the base of the tool. Rotate the spindle counter clockwise, by hand 3-4 revolutions. Reinstall the air hose and run the tool for a minute or two. (Replacement containers of oil may be purchased from Alpha Professional Tools® Part # AIR-008.)

Maintenance and Usage Tip

Automatic oilers are not recommended: the volume, grade, and composition of oil used may cause premature failure. In-line air dryers are recommended to extend the life of the tool. Old or worn compressors, which emit oil through the air lines, can dramatically shorten the life of the tool.

► SPINDLE SIZE

The Alpha® AIR-300 air polisher features a 5/8"-11 size spindle. This tool has been designed for portable/shop production and uses all modern accessories. It is very important that you do not run anything heavier than the recommended accessories on this machine. A drop of oil should be applied to the outside threads whenever attachments are changed to facilitate removal and prevent rust. A 17mm Spindle Wrench is provided to assist in changing accessories.

Maintenance and Usage Tip

- Do not leave the tool submersed in water. This could expose the inner moving parts to moisture, which will shorten the life of the tool.
- Do not leave threaded accessories (backer pads) on the spindle of tool for extended periods of time; this may result in making it difficult to remove these accessories.
- Excessive force or impact to the spindle may result in premature failure of gears and/or bearings, which may not be immediately evident.

► AIR VALVE LEVER

The valve lever controls the flow of air through the tool. It has two positions- ON or OFF. Run the tool at the recommended range of 87 PSI, with the lever pointing to the ON position. This will produce 5,800 RPM. Do not try to vary the speed. The tool works best at full throttle only. Do not attempt to exceed the recommended speed by excess pressure.

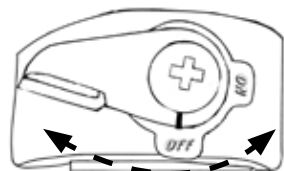

Figure-11

► WATER CONTROL VALVE

This valve lets you adjust the flow of water through the spindle. It may be used to shut off the water entirely when changing discs. When storing the tool overnight, open the valve and drain all water from the supply hose and tool.

Maintenance and Usage Tip

Do not apply more force or pressure than the force created by the weight of the polisher itself. The polishing discs are designed to work properly under lightweight pressure. Applying excessive force or pressure may damage the disc and could shorten the life of the tool.

► WATER SUPPLY HOSE

This hose may be connected to any garden hose using a clamp. The hose is composed of a special material to avoid kinks. Replacements are available should the hose become damaged, Part # 133229.

► SILENCER / MUFFLER

To comply with OSHA Occupational Noise Exposure Standard Number 1926.52, this polisher is equipped with an internal Silencer System. When the polisher is operated correctly at 87 PSI, the sound level emitted should be less than 80 dBA. The internal Silencer System is also used to maintain a constant back pressure inside the tool; this helps prevent it from exceeding the recommended 5,800 RPM. The exhaust hose for this tool also helps to reduce the noise level by venting the exhaust air and residual air-line, thus eliminating the risk of excess lubricant dripping on the work piece.

► MAXIMUM SIZE FOR POLISHING PADS

The Alpha® AIR-300 accepts ONLY 3" and 4" discs along with 2", 3" and 4" rubber pads.

► ALPHA® AIR-300 MINI AIR POLISER SCHEMATIC

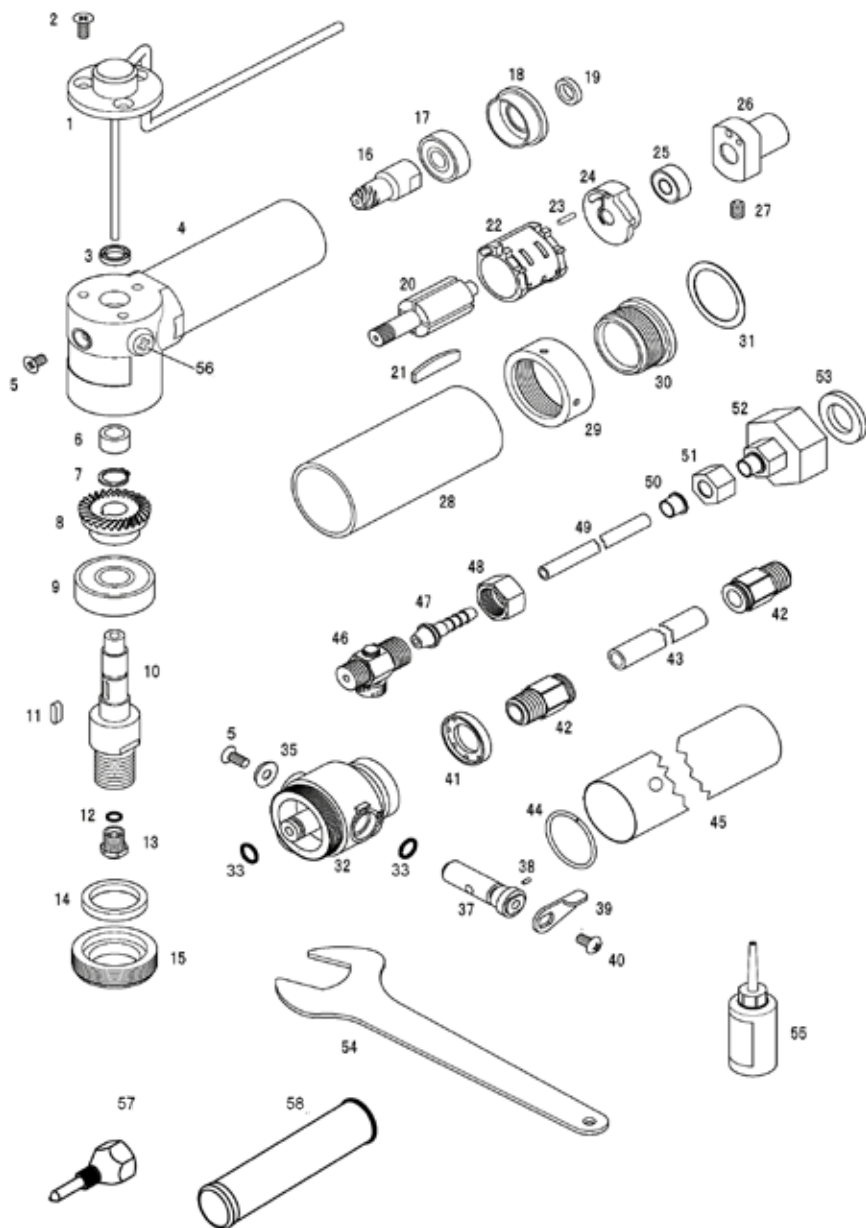

► ALPHA® AIR-300 MINI AIR POLISHER PARTS LIST

DRAWING NO.	PART NO.	DESCRIPTION	QUANTITY
1	300001	Water-Feed Assembly	1
2	300002	Screw M4x10	3
3	300003	Oil Seal	1
4	300004	Body	1
5	300005	Screw M4x6	2
6	300006	Needle Bearing FJ810W	1
7	300007	Snap Ring S-10	1
8	300008	Spiral Bevel Gear	1
9	300009	Ball Bearing 6201ZZ	1
10	300010	Spindle 5/8"-11	1
11	300011	Oval Key 3x3x10	1
12	300012	O-Ring KS-1	1
13	300013	Nozzle 5/16	1
14	300014	Oil Seal OS20264	1
15	300015	Nut M34 Left Hand	1
16	300016	Spiral Bevel Pinion	1
17	516-20	Ball Bearing 608ZZ	1
18	300017	F-Bearing Case	1
19	300018	Rotor Spacer	1
20	300019	Rotor	1
21	300020	Vane	4
22	300021	Cylinder	1
23	300022	Spring Pin ϕ 2.5X15	1
24	300023	R-Bearing Case	1
25	300024	Bearing R4ZZ	1
26	300025	Intake Manifold	1
27	300026	Set Screw (M5x6)	1
28	300027	Grip Cover	1
29	300028	Nut ϕ 38	1
30	300029	Retainer Nut	1
31	300030	Gasket ϕ 32	1
32	300031	Endcase	1
33	300049	O-Ring KS-5	2
35	300032	Conical Washer M4	1
37	300033	Valve	1
38	300034	Needle Pin ϕ 1.5x3.8	1

► ALPHA® AIR-300 MINI AIR POLISHER PARTS LIST

DRAWING NO.	PART NO.	DESCRIPTION	QUANTITY
39	300035	Valve Lever	1
40	300036	Screw M4x6	1
41	300037	Silencer	1
42	300038	Hose Fitting $\varnothing 8$	2
43	300039	Air Hose 8Dx6d 10ft (3m)	1
44	300040	Hose Band	1
45	300041	Exhaust Hose (leather)	1
46	300042	Water Valve	1
47	300043	Hose Insert	1
48	300044	Union Nut	1
49	133229	Water Hose 8mm ODx10ft (3m)	1
50	AWP-56	Compression Ring	1
51	AWP-57	Compression Nut	1
52	AWP-74	Hose Coupling	1
53	AWP-75	Gasket 24x14x3	1
54	300046	Wrench 17mm	1
55	AIR-008	Rust Inhibitor Oil 8oz (237ml)	1
56	300045	Screw M5x6	2
57	300050	Needle Point Coupler	1
58	300051	Grease Cartridge (14oz)	1

► APPENDIX A

Greasing The Tool Housing

1. Using a Phillips screwdriver, remove filler screw from grease filler hole.

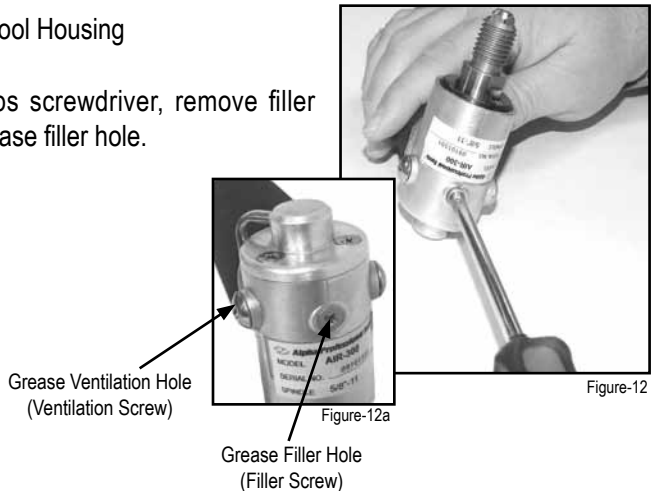

2. Remove the vent screw from the ventilation hole. The ventilation hole is located near the water pipe as shown above.



Figure-13

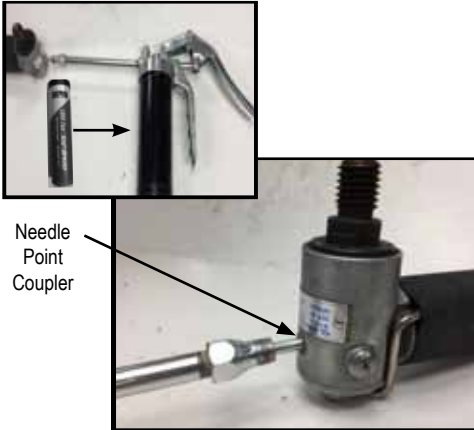

Figure-14

3. Test the needle point coupler to make sure grease is coming out. Insert needle point coupler tip into filler hole and pump two or three times to inject grease into the tool housing.



Figure-15

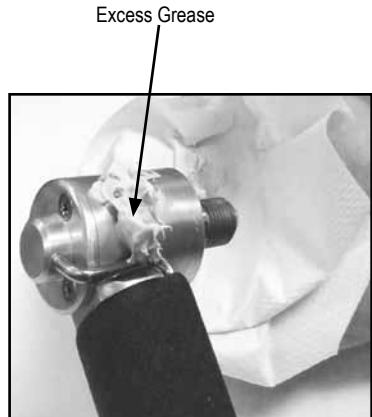

Figure-16

4. Reinstall filler screw, then reconnect the tool to air making sure air valve is in the OFF position. Turn on tool for 4-5 seconds to remove excess grease.

5. Reinstall vent screw and clean grease from the outside of tool.

NOTE: Venting must be done every time grease is added to prevent grease from seeping onto the spindle shaft when polishing.

► ACCESSORIES AND FACTORY SERVICE

All the accessories can be purchased at a local distributor in your area. The Alpha® AIR-300 accepts 3" and 4" discs along with 2", 3" and 4" rubber pads. It requires a 3HP compressor with air consumption of 10 CFM and air pressure between 85–95 PSI that makes on-site applications possible. For more information concerning Alpha® Air Polisher and factory service, please contact Alpha®.

COMPANY HEADQUARTERS: Alpha Professional Tools®
103 Bauer Drive
Oakland, NJ 07436

Hours of Operation: 8:30 a.m. – 5:00 p.m. EST

Telephone Number: 201-337-3343

Toll-Free Number: 800-648-7229

Website: www.alpha-tools.com

Limited Warranty of Alpha® Air Polisher (AIR-300) for the USA and Canada ONLY!

Alpha Professional Tools® warrants this product against defects in material and workmanship for a period of 90 days from the date of original retail purchase (proof of purchase required). If Alpha Professional Tools® receives notice of such defects during the warranty period, our obligation assumed under this warranty is limited to the repair or replacement of parts, without charge. This warranty does not apply to tool accessories.

For Warranty Claims: Send complete tool with all your information and details of the problem to the Alpha Professional Tools®, transportation prepaid. Do not send tool accessories.

NOTE: *Any tools purchased through an unauthorized distributor are not covered under warranty.*

PRODUCT REGISTRATION CARD

Model No.

Serial No.

Company Name: _____

Name: _____

Address: _____

City: _____ State: _____ Zip: _____

Telephone: _____

Purchase Date: _____

Dealer's Name: _____

Note: Serial & Model Number must be included for proper registration.



Alpha Professional Tools®

(800) 648-7229



Register online at:

www.alpha-tools.com/productregistration.aspx

Mail or Fax to:

Alpha Professional Tools®

103 Bauer Drive, Oakland, NJ 07436

Fax: 800-286-0114

Photocopy of product registration form will be accepted.



103 Bauer Drive, Oakland, NJ 07436 • 800-648-7229 • Fax: 800-286-0114
www.alpha-tools.com

Copyright © 2010 Alpha Professional Tools. All rights reserved.

01/2010
